

SECURITY DESK

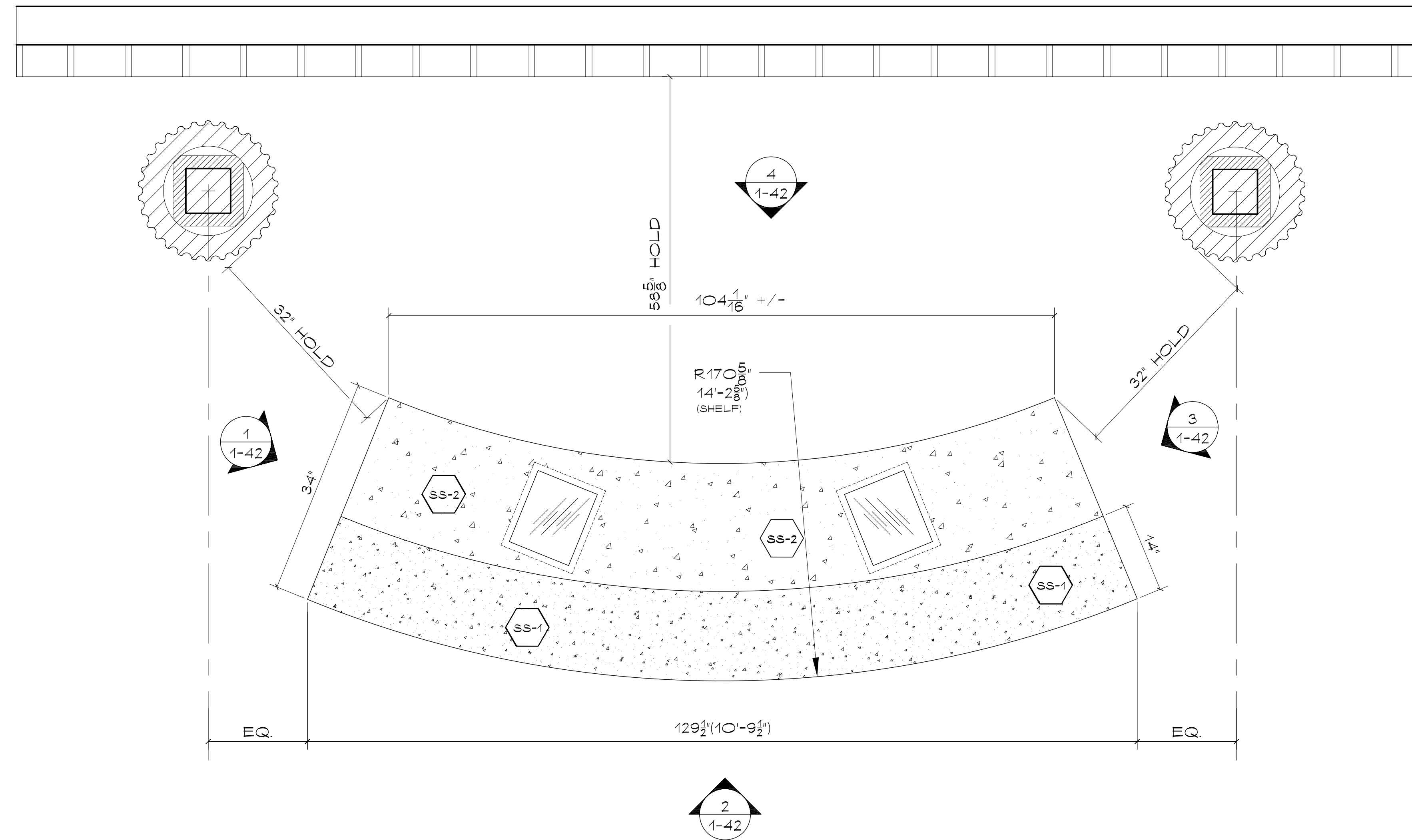

1 PLAN
SC. 1/4"=1'-0"

REV.#/BY	DATE	REVISION
	06/27/08	1ST SUBMITTAL

PICCINI
ARCHITECTURAL WOODWORK

37 RAMLAND RD.
ORANGEBURG, N.Y. 10962
PHONE# 845-357-5006
FAX# 845-357-3351

ARCHITECT: STV INC

GC: T.A. AHERN CONTRACTORS

PROJECT: PS/1S 102 QUEENS
55-24 VAN HORN STREET
ELMHURST, NY 11377

MILLWORK ITEMS:
SECURITY DESK
PLAN

SCALE: AS NOTED BY: N.M. DATE: 06/11/08

JOB NO. 4077 DRAWING NO. 1-41

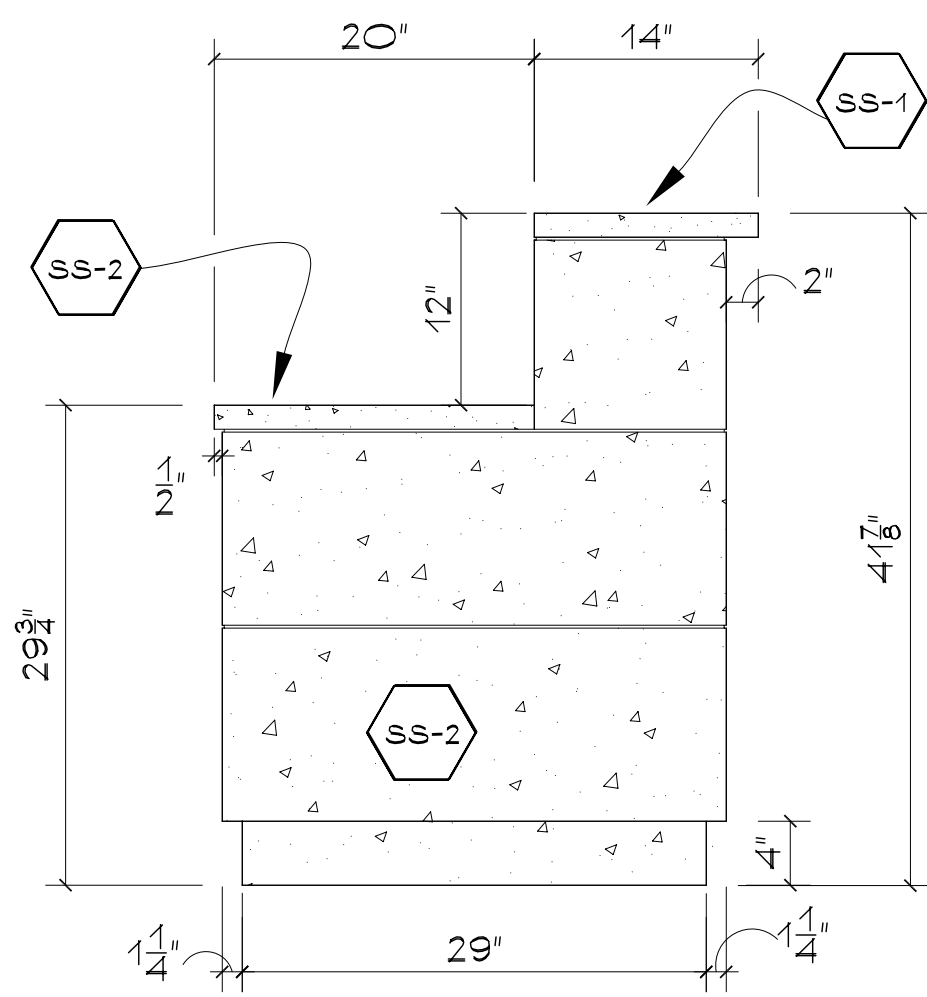

1 ELEVATION
SC. 1/4"=1'-0"

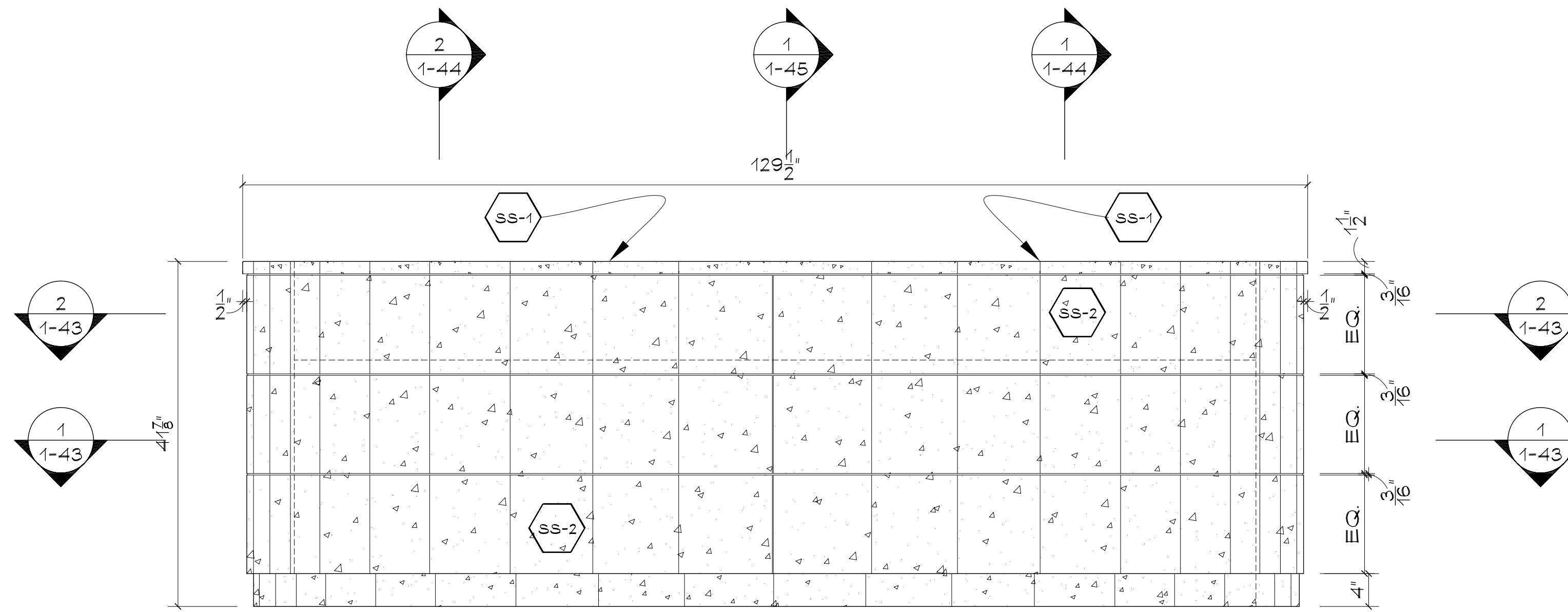

2 ELEVATION
SC. 1/4"=1'-0"

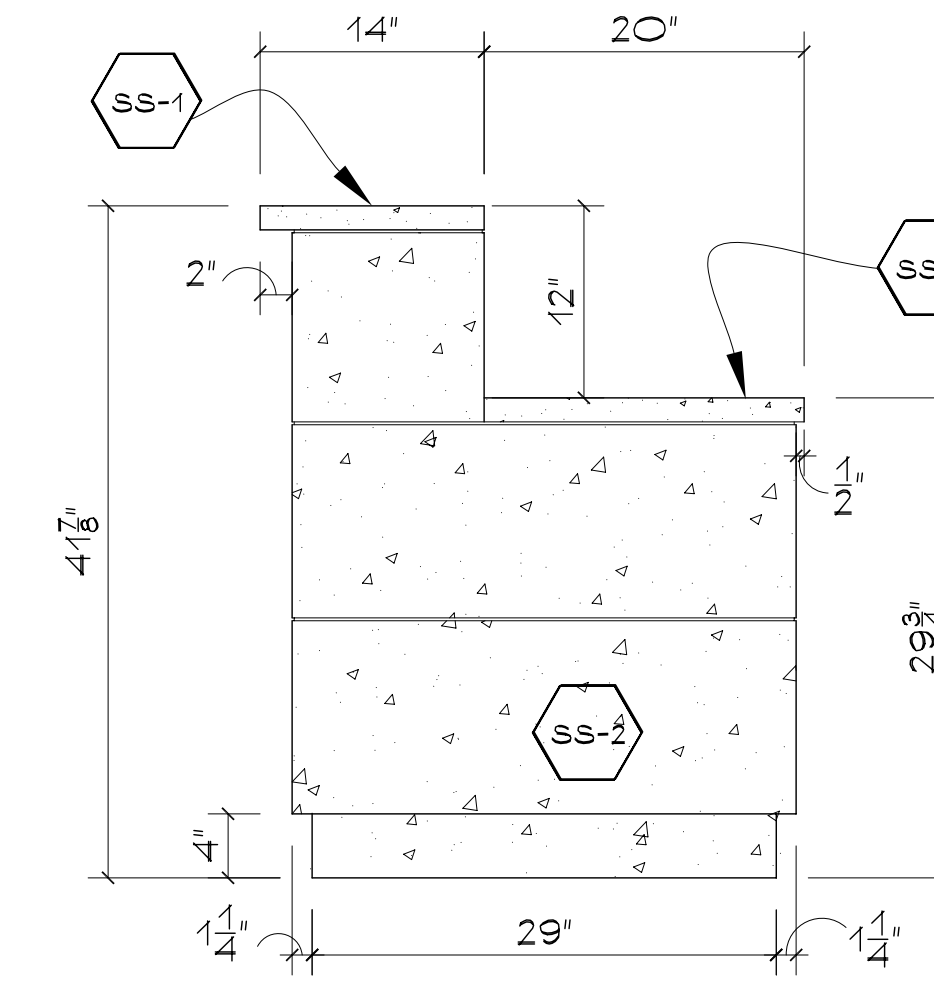

3 ELEVATION
SC. 1/4"=1'-0"

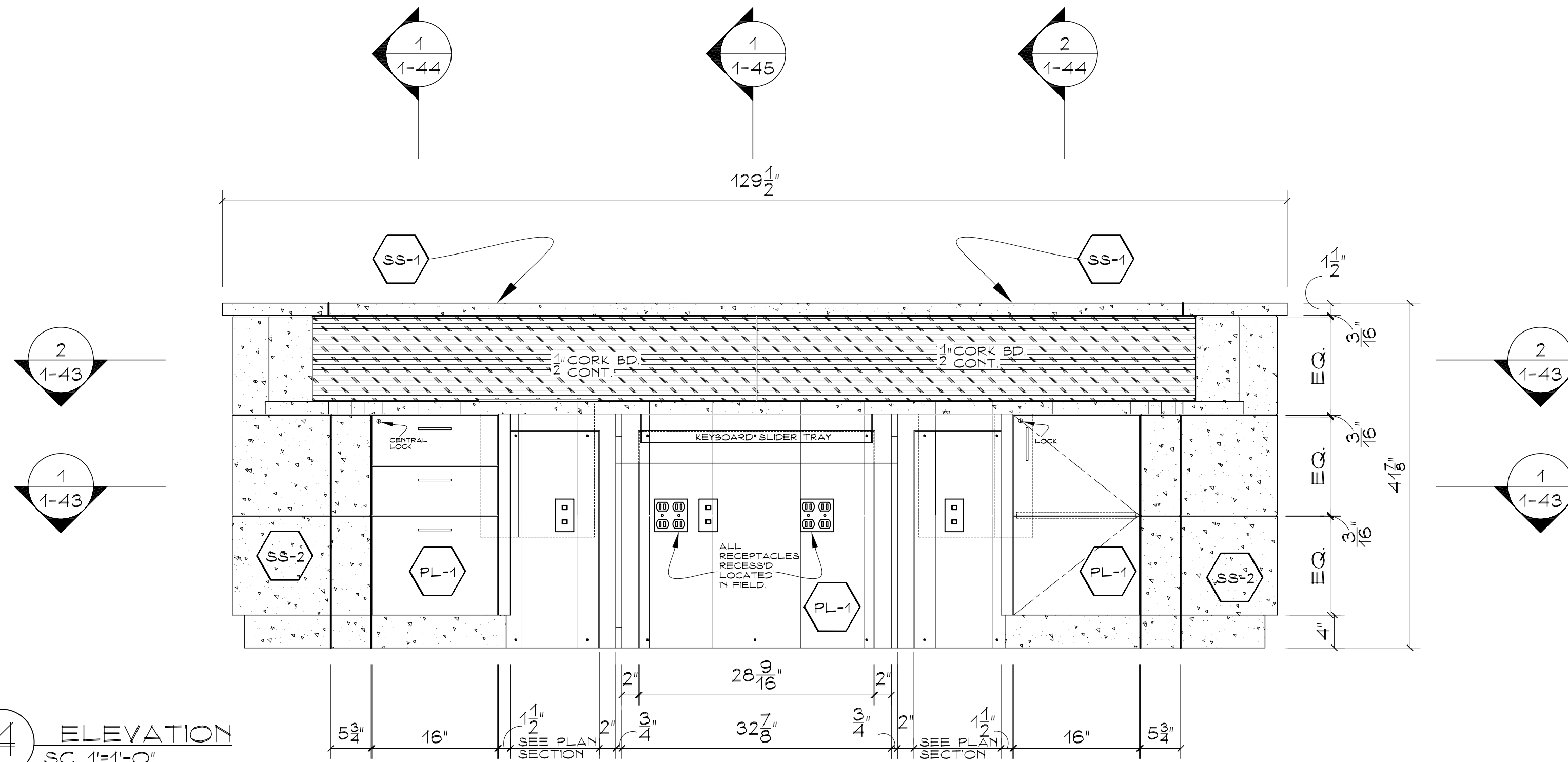

4 ELEVATION
SC. 1/4"=1'-0"

CONSTRUCTION SPECIFICATIONS

CASEWORK:
3/4" WHITE MELAMINE
1/4" WHITE MELAMINE

DOORS:
3/4" FLAKE BOARD
PLASTIC LAMINATE FINISH
BOTH SIDES AND FOUR EDGES

DRAWERS:
5/8" WHITE MELAMINE
1/4" WHITE MELAMINE

COUNTER TOPS:
CORIAN TOP 1/2" FRONT EDGE.

FINISH:
SS-1= CORIAN VERIFY COLOR.
SS-2= CORIAN VERIFY COLOR.
PL-1= VERIFY COLOR.

HARDWARE:
HINGES= SALICE 110
SLIDES= BLUM 230M
PULLS= 4" BRUSH CHROME
SHELF PIN= CLEAR FOR 5MM.
LOCK=CAM-LOCK KEYED ALIKE

MISCELLANEOUS

NOTES

REV.#/BY	DATE	REVISION
	06/27/08	1ST SUBMITTAL

PICCINI
ARCHITECTURAL WOODWORK

37 RAMLAND RD.
ORANGEBURG, N.Y. 10962
PHONE# 845-357-5006
FAX# 845-357-3351

ARCHITECT: STV INC

GC: T.A AHERN CONTRACTORS

PROJECT:
PS/1S 102 QUEENS
55-24 VAN HORN STREET
ELMHURST, NY 11377

MILLWORK ITEMS:
SECURITY DESK
ELEVATIONS

SCALE: AS NOTED BY: N.M DATE: 06/11/08

JOB NO. 4077 DRAWING NO. 1-42

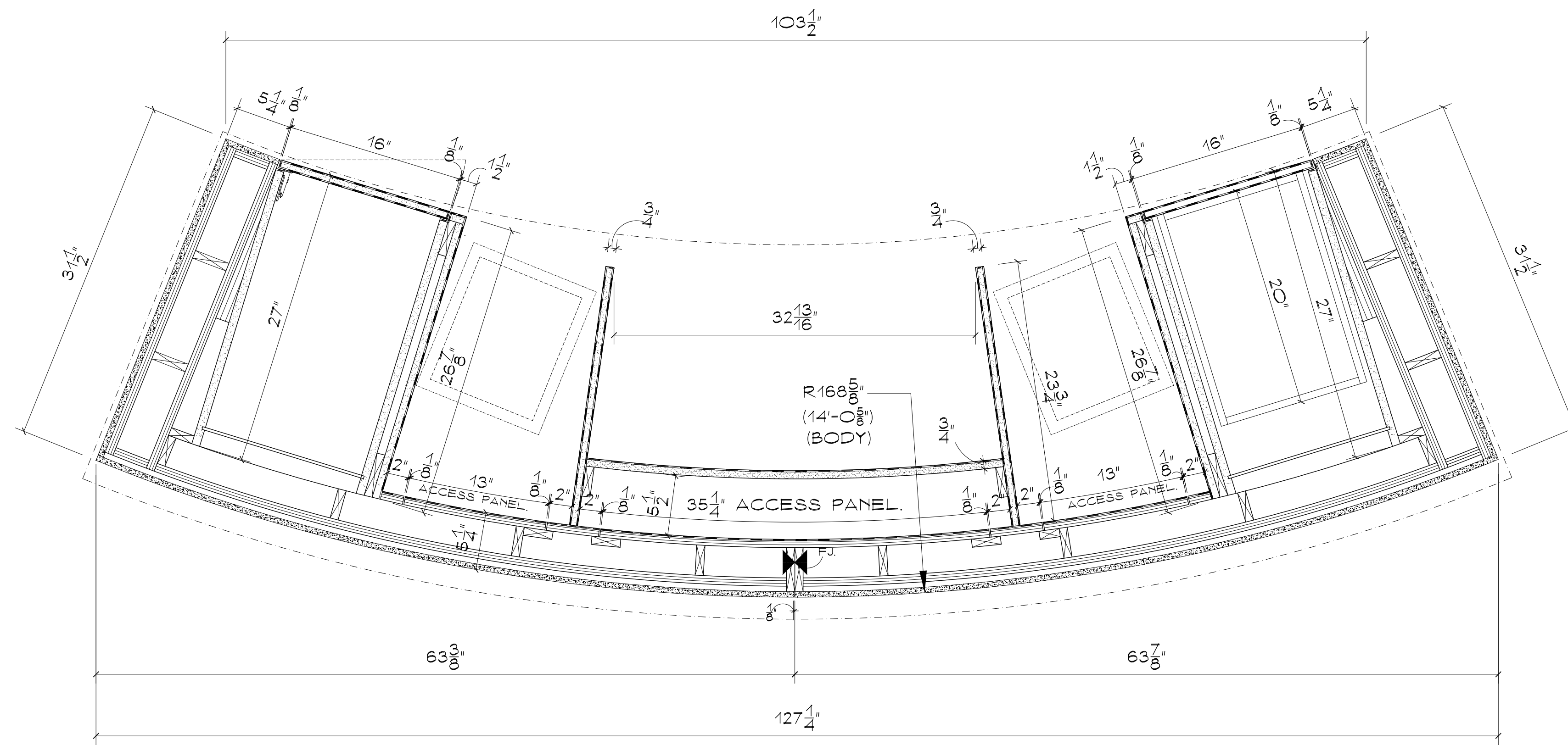

1 PLAN SECTION
SC. 1 1/2"=1'-0"

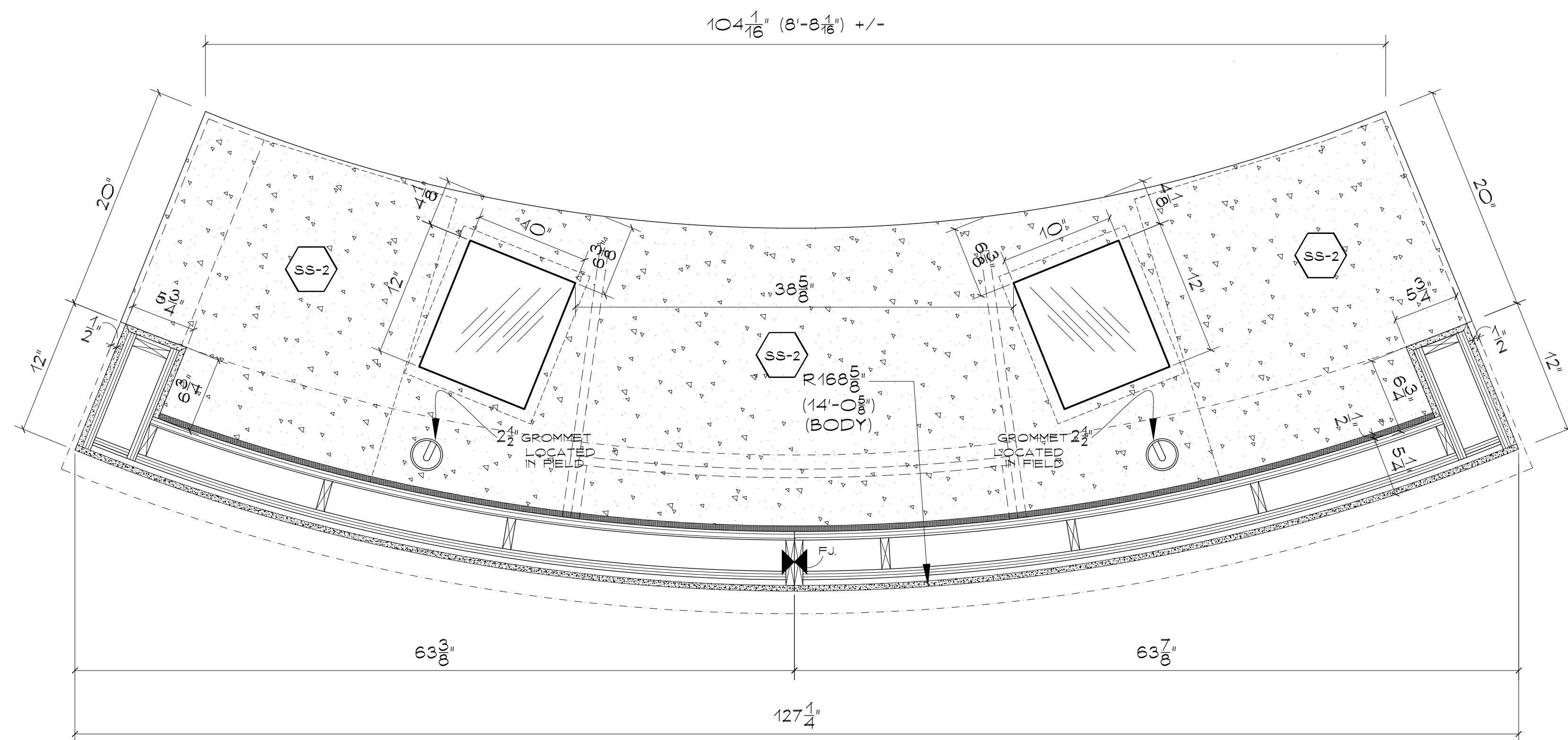

2 PLAN SECTION
SC. 1 1/2"=1'-0"

REV.#/BY	DATE	REVISION
	06/27/08	1ST SUBMITTAL

PICCINI
ARCHITECTURAL WOODWORK

37 RAMLAND RD.
ORANGEBURG, N.Y. 10962
PHONE# 845-357-5006
FAX# 845-357-3351

ARCHITECT: STV INC

GC: T.A. AHERN CONTRACTORS

PROJECT: PS/1S 102 QUEENS
55-24 VAN HORN STREET
ELMHURST, NY 11377

MILLWORK ITEMS:
SECURITY DESK
PLAN SECTIONS

SCALE: AS NOTED BY: N.M. DATE: 06/11/08

JOB NO. 4077 DRAWING NO. 1-43

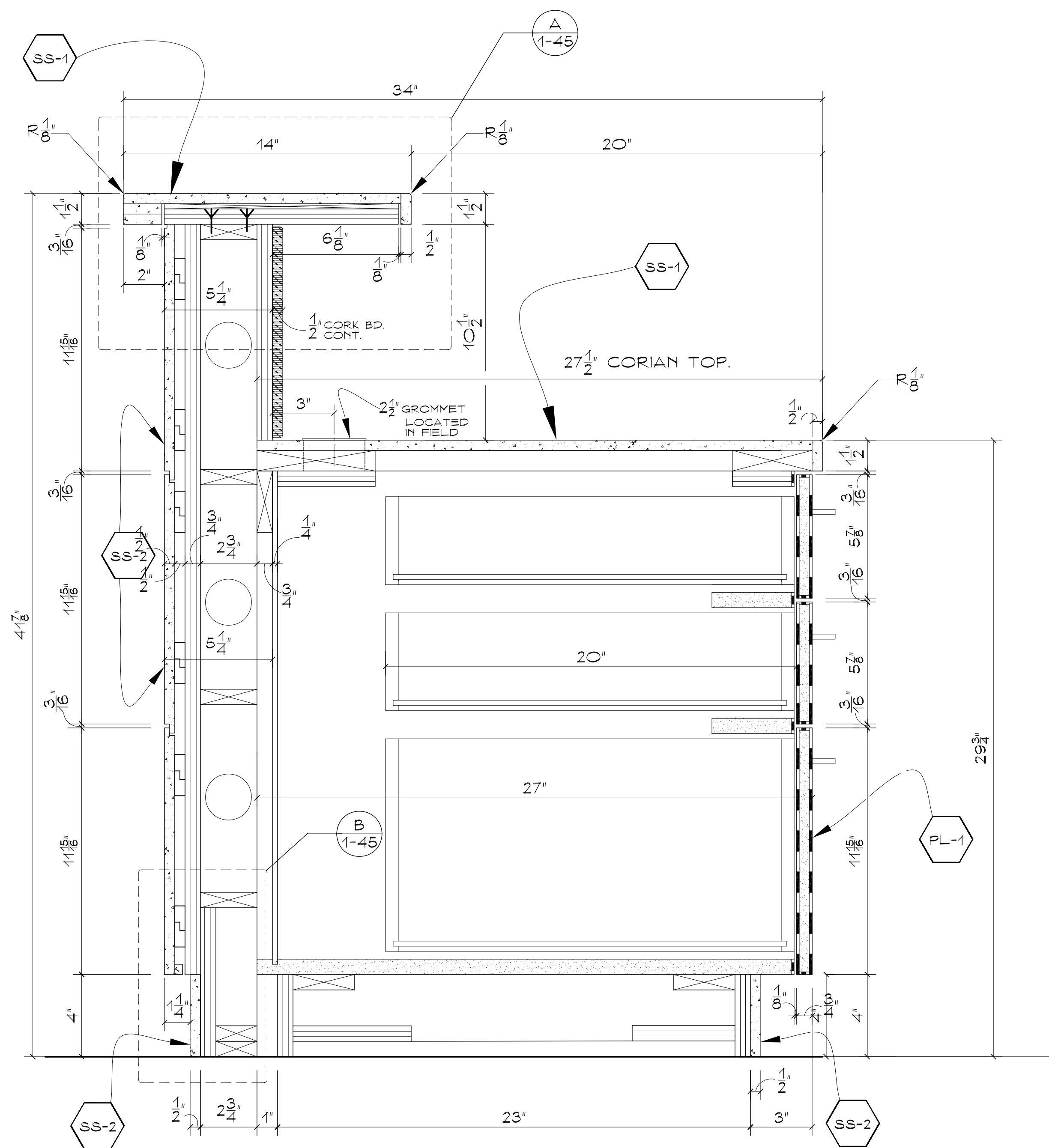

1 SECTION
SC. 3/4"=1'-0"

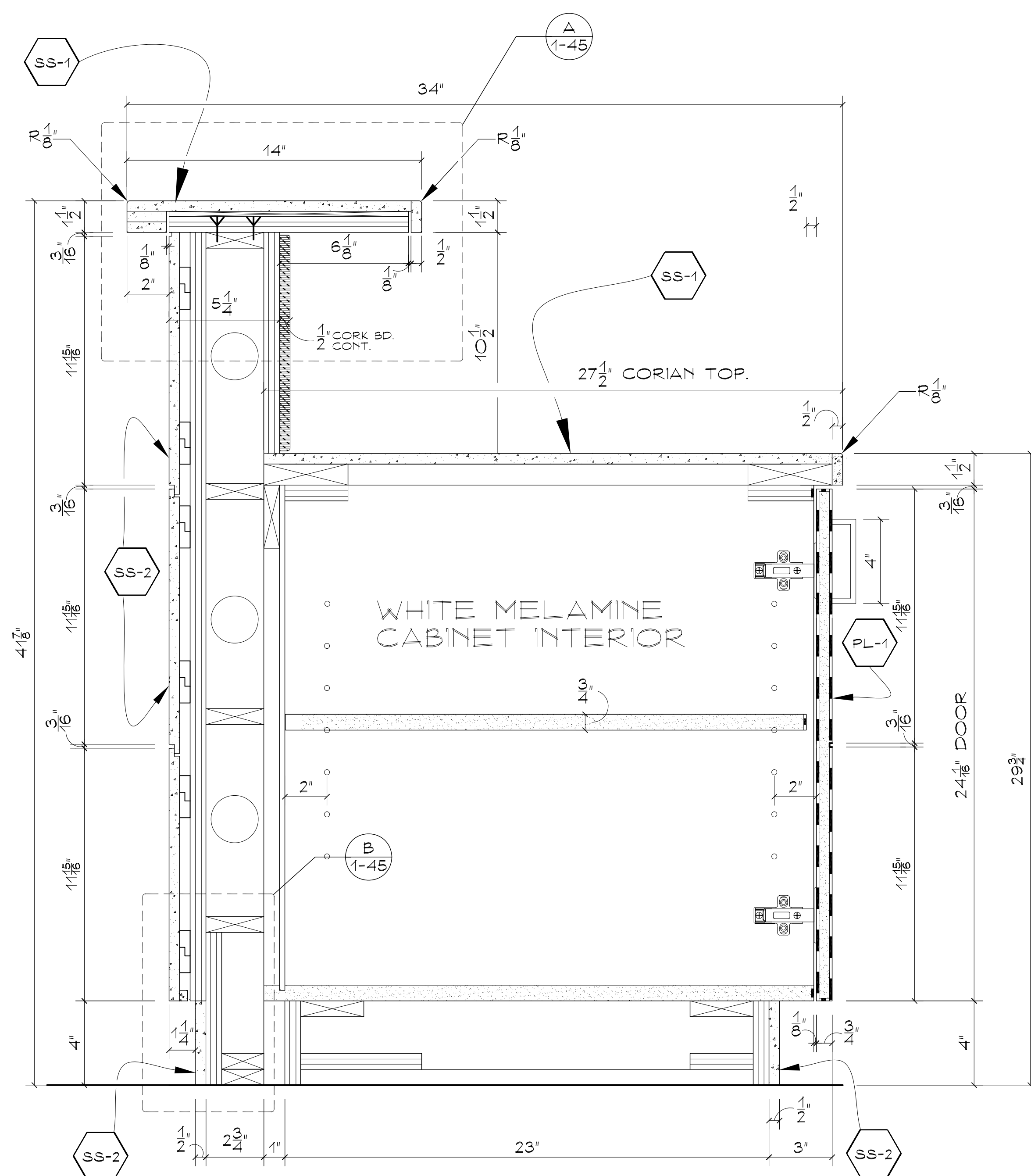

2 SECTION
SC. 3/4"=1'-0"

REV.#/BY	DATE	REVISION

PICCINI
ARCHITECTURAL WOODWORK

37 RAMLAND RD.
ORANBURG, N.Y. 10962
PHONE# 845-357-5006
FAX# 845-357-3351

ARCHITECT: STV INC

GC: T.A. AHERN CONTRACTORS

PROJECT: PS/IS 102 QUEENS
55-24 VAN HORN STREET
ELMHURST, NY 11377

MILLWORK ITEMS:
SECURITY DESK
PLAN SECTIONS

SCALE: AS NOTED BY: N.M. DATE: 06/11/08

JOB NO. 4077 DRAWING NO. 1-44

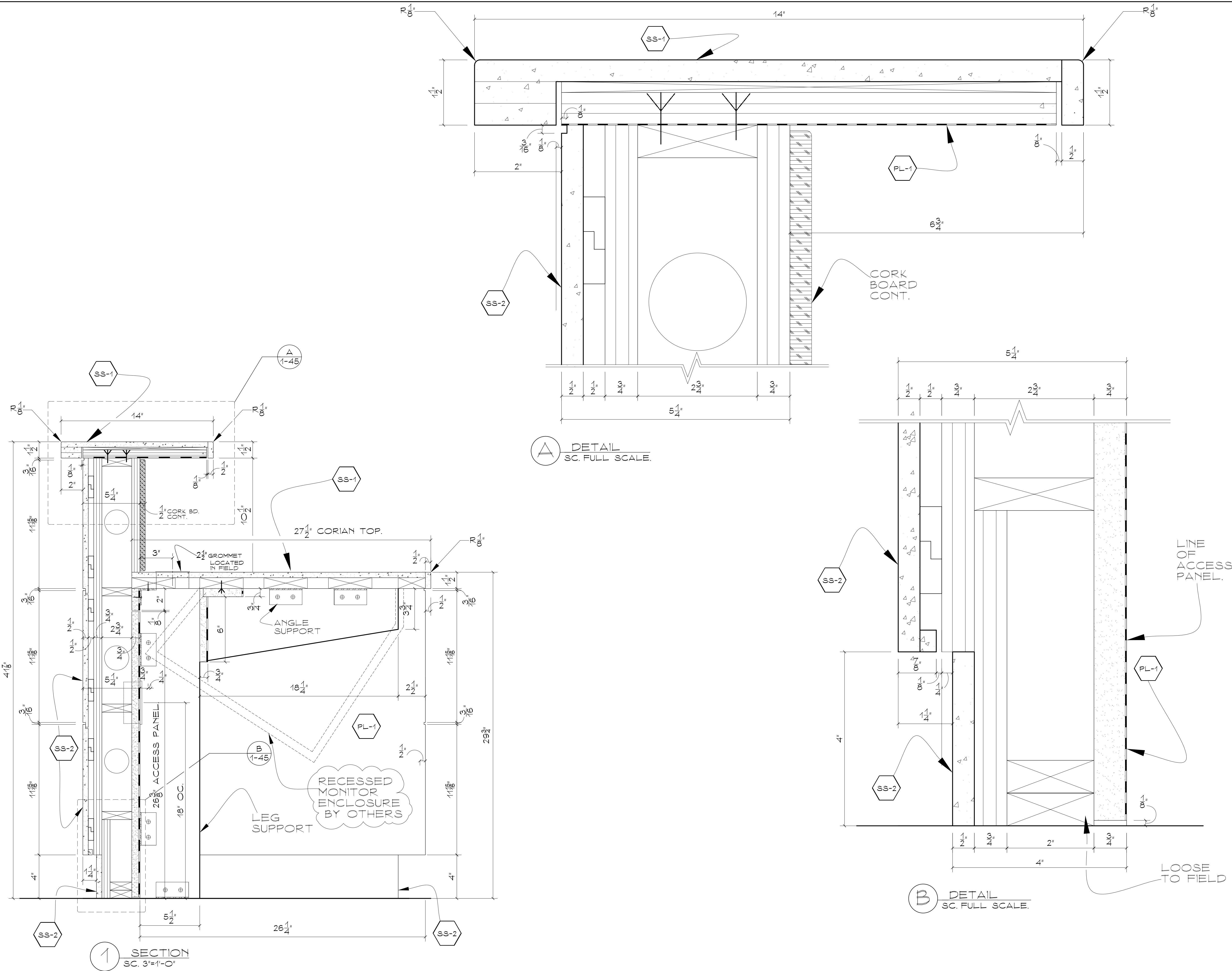

REV.#/BY	DATE	REVISION
	06/27/08	1ST SUBMITTAL

PICCINI
ARCHITECTURAL WOODWORK

37 RAMLAND RD.
ORANBURG, N.Y. 10962
PHONE# 845-357-5006
FAX# 845-357-3351

ARCHITECT: STV INC

GC: T.A. AHERN CONTRACTORS

PROJECT: PS/IS 102 QUEENS
55-24 VAN HORN STREET
ELMHURST, NY 11377

MILLWORK ITEMS:
SECURITY DESK
PLAN SECTIONS

SCALE: AS NOTED	BY: N.M.	DATE: 06/11/08
JOB NO. 4077	DRAWING NO. 1-45	